

REV	BY	DESCRIPTION	DATE
03			
02			
01	CJH	Drawing released	5/18/22

SHIELD
Cable - 3C/18GA

NOTE: REMOVE A FACTORY JUMPER AND RUN EN1, EN2, AND PLC WIRE TO TERMINAL STRIP

THIS DRAWING IS THE PROPERTY OF
INNOVATE IT

THIS DRAWING MUST NOT BE COPIED WITHOUT EXPRESS WRITTEN PERMISSION OF INNOVATE IT CAR WASH EQUIPMENT.
DESIGN RIGHT
ALL DESIGN RIGHTS RECORDED IN THIS DESIGN DOCUMENT ARE THE PROPERTY OF INNOVATE IT CAR WASH EQUIPMENT. THE DESIGN MUST NOT BE REPRODUCED WITHOUT EXPRESS WRITTEN PERMISSION OF INNOVATE IT CAR WASH EQUIPMENT.
CONFIDENTIALITY
THIS DRAWING MUST NOT BE DISCLOSED TO ANY THIRD PARTY WITHOUT THE EXPRESS WRITTEN PERMISSION OF INNOVATE IT CAR WASH EQUIPMENT.

APPROVALS	DATE	INNOVATE IT CAR WASH EQUIPMENT	
DRAWN CJH	5/18/22	PROJECT: Wheel Blaster	
CHKD		TITLE: Wheel Blaster VFDs	
APPRVD		DRAWING NO: Wheel Blaster_480-120V_Wiring_ETH_Maple	
ENG. INFO	XXXX	SIZE:	SCALE: NONE
		SHEET: PAGE 1 OF 10	REV: 02

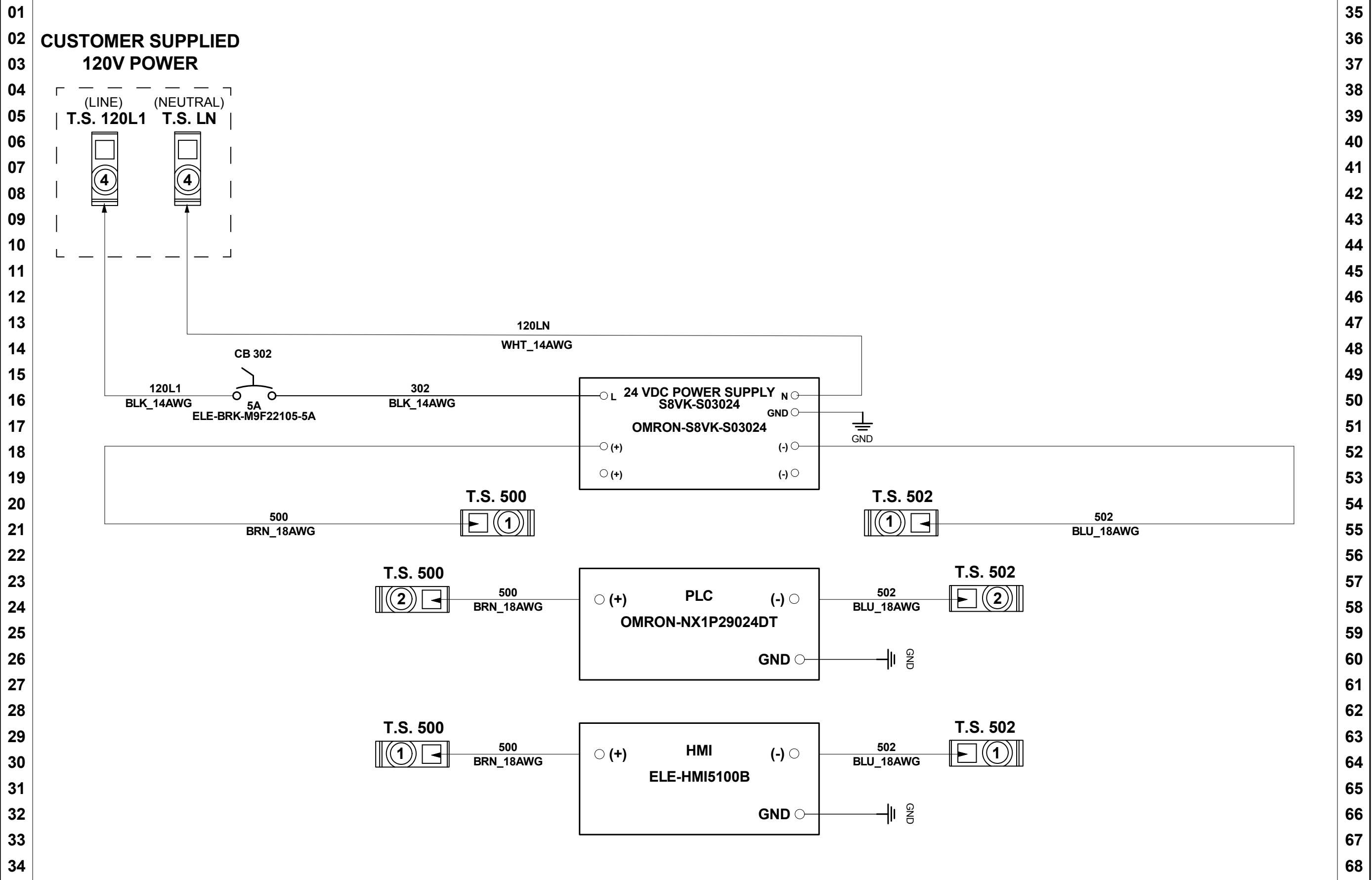

03			
02			
01	CJH	Drawing released	5/18/22
REV	BY	DESCRIPTION	DATE

THIS DRAWING IS THE PROPERTY OF INNOVATEIT		APPROVALS	DATE	INNOVATE IT CAR WASH EQUIPMENT	
THIS DRAWING MUST NOT BE COPIED WITHOUT EXPRESS WRITTEN PERMISSION OF INNOVATE IT CAR WASH EQUIPMENT.		DRAWN CJH	5/18/22	PROJECT: Wheel Blaster	
DESIGN RIGHT ALL DESIGN RIGHTS RECORDED IN THIS DESIGN DOCUMENT ARE THE PROPERTY OF INNOVATE IT CAR WASH EQUIPMENT. THE DESIGN MUST NOT BE REPRODUCED WITHOUT EXPRESS WRITTEN PERMISSION OF INNOVATE IT CAR WASH EQUIPMENT.		CHKD		TITLE: AC / DC Power Distribution	
CONFIDENTIALITY THIS DRAWING MUST NOT BE DISCLOSED TO ANY THIRD PARTY WITHOUT THE EXPRESS WRITTEN PERMISSION OF INNOVATE IT CAR WASH EQUIPMENT.		APPRVD		DRAWING NO: Wheel Blaster_480-120V_Wiring_ETH_Maple	
		ENG. INFO	XXXX	SIZE:	SCALE: NONE
		DO NOT SCALE DWG.		SHEET: PAGE 2 OF 10	REV: 02

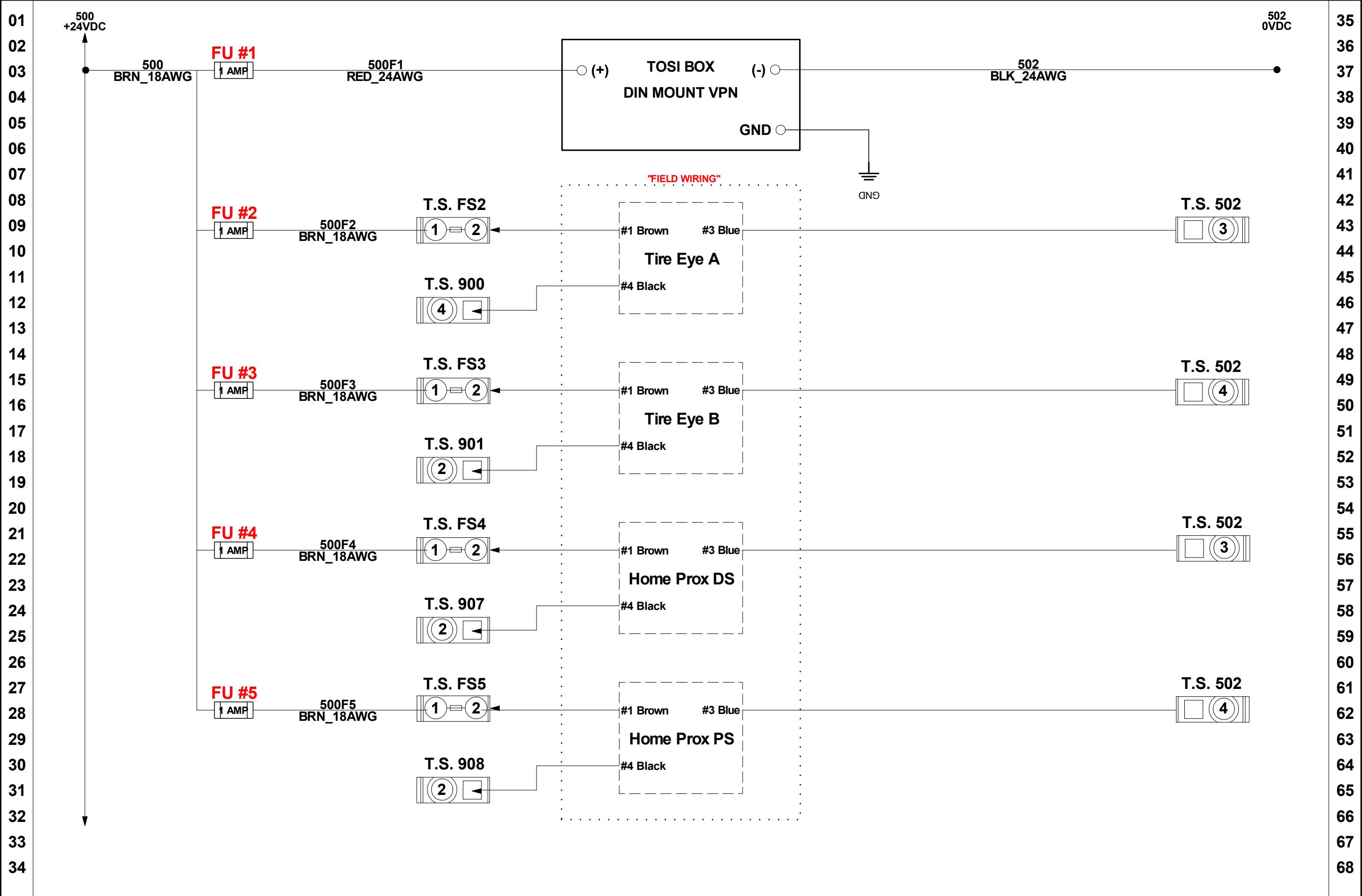

REV	BY	DESCRIPTION	DATE
03			
02			
01	CJH	Drawing released	5/18/22

THIS DRAWING IS THE PROPERTY OF INNOVATE IT		APPROVALS	DATE	INNOVATE IT CAR WASH EQUIPMENT	
THIS DRAWING MUST NOT BE COPIED WITHOUT EXPRESS WRITTEN PERMISSION OF INNOVATE IT CAR WASH EQUIPMENT. DESIGN RIGHT ALL DESIGN RIGHTS RECORDED IN THIS DESIGN DOCUMENT ARE THE PROPERTY OF INNOVATE IT CAR WASH EQUIPMENT. THE DESIGN MUST NOT BE REPRODUCED WITHOUT EXPRESS WRITTEN PERMISSION OF INNOVATE IT CAR WASH EQUIPMENT. CONFIDENTIALITY THIS DRAWING MUST NOT BE DISCLOSED TO ANY THIRD PARTY WITHOUT THE EXPRESS WRITTEN PERMISSION OF INNOVATE IT CAR WASH EQUIPMENT.		DRAWN CJH	5/18/22	PROJECT: Wheel Blaster	
		CHKD		TITLE: DC Fuse Distribution	
		APPRVD		DRAWING NO: Wheel Blaster_480-120V_Wiring_ETH_Maple	
		ENG. INFO	XXXX	SIZE:	SCALE: NONE
		DO NOT SCALE DWG.		SHEET: PAGE 3 OF 10	REV: 02

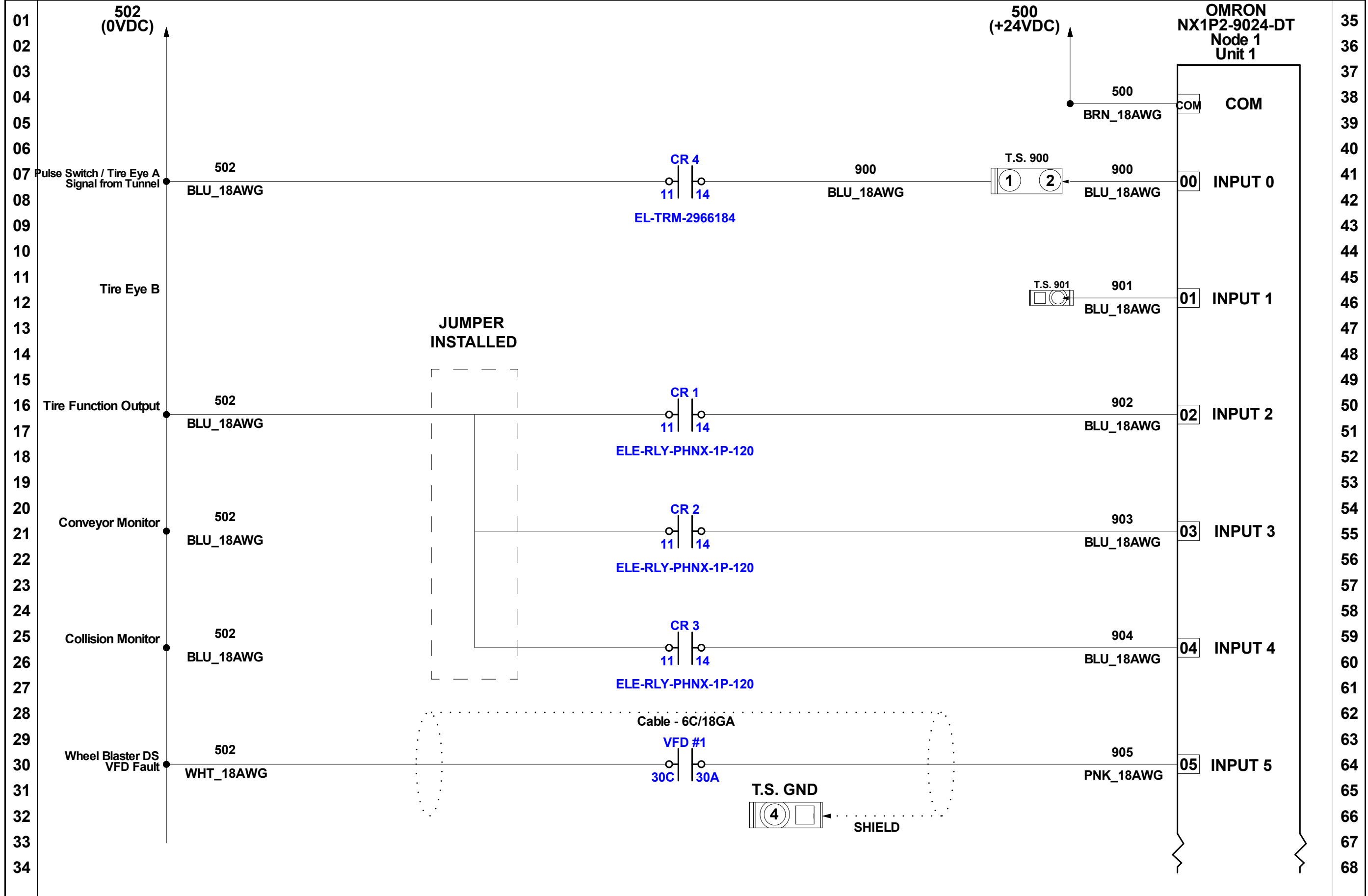

Note:
Connect shield wire to ground on PLC side of cable

REV	BY	DESCRIPTION	DATE
03			
02			
01	CJH	Drawing released	5/18/22

THIS DRAWING IS THE PROPERTY OF INNOVATE IT		APPROVALS	DATE	INNOVATE IT CAR WASH EQUIPMENT	
THIS DRAWING MUST NOT BE COPIED WITHOUT EXPRESS WRITTEN PERMISSION OF INNOVATE IT CAR WASH EQUIPMENT. DESIGN RIGHT ALL DESIGN RIGHTS RECORDED IN THIS DESIGN DOCUMENT ARE THE PROPERTY OF INNOVATE IT CAR WASH EQUIPMENT. THE DESIGN MUST NOT BE REPRODUCED WITHOUT EXPRESS WRITTEN PERMISSION OF INNOVATE IT CAR WASH EQUIPMENT. CONFIDENTIALITY THIS DRAWING MUST NOT BE DISCLOSED TO ANY THIRD PARTY WITHOUT THE EXPRESS WRITTEN PERMISSION OF INNOVATE IT CAR WASH EQUIPMENT.		DRAWN CJH	5/18/22	PROJECT: Wheel Blaster	
		CHKD		TITLE: PLC Inputs 0-5	
		APPRVD		DRAWING NO: Wheel Blaster_480-120V_Wiring_ETH_Maple	
		ENG. INFO	XXXX	SIZE:	SCALE: NONE
		DO NOT SCALE DWG.		SHEET: PAGE 4 OF 10	REV: 02

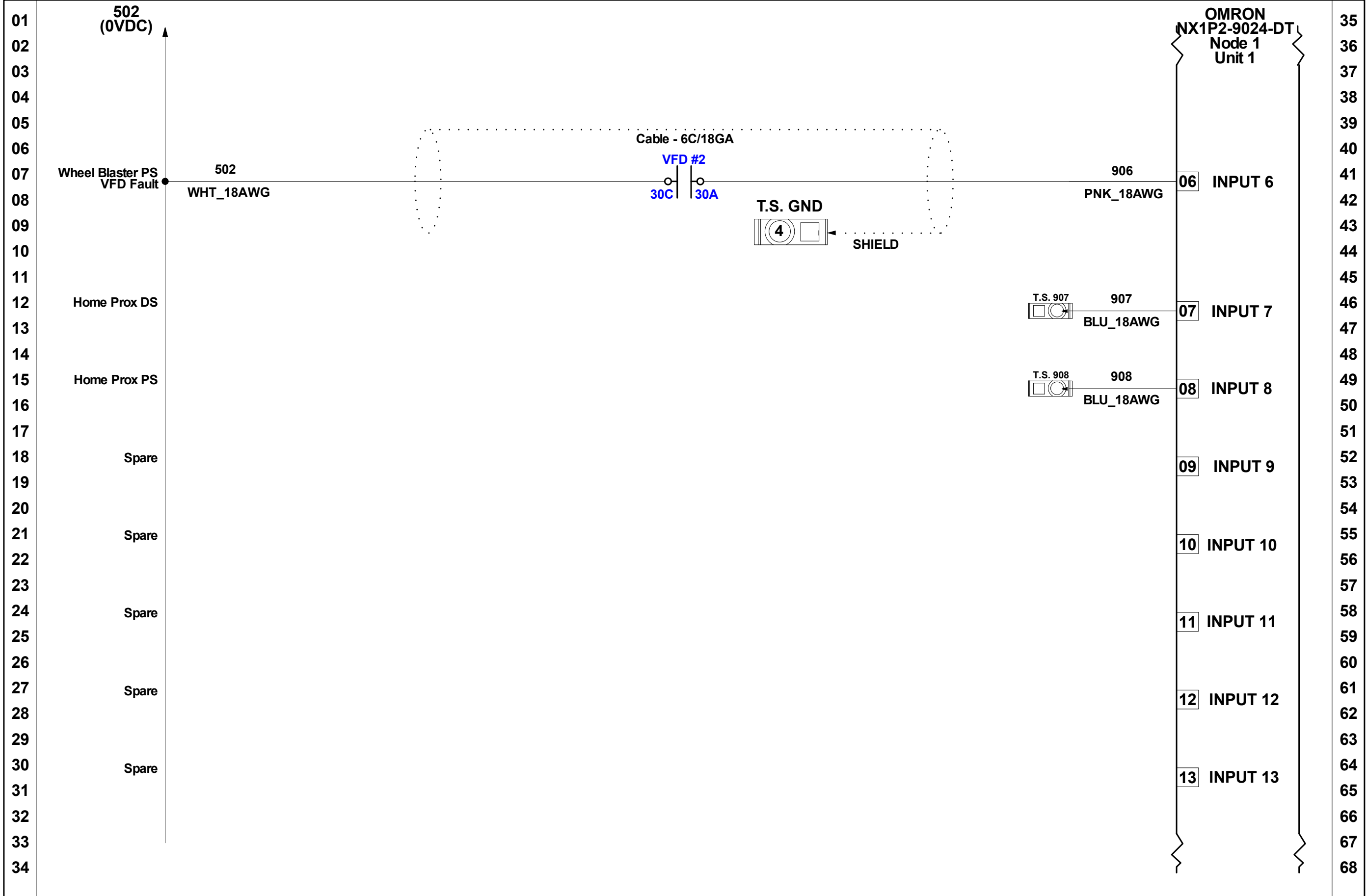

03			
02			
01	CJH	Drawing released	5/18/22
REV	BY	DESCRIPTION	DATE

Note:
Connect shield wire to ground on PLC side of cable

THIS DRAWING IS THE PROPERTY OF INNOVATE IT		APPROVALS	DATE	INNOVATE IT CAR WASH EQUIPMENT	
THIS DRAWING MUST NOT BE COPIED WITHOUT EXPRESS WRITTEN PERMISSION OF INNOVATE IT CAR WASH EQUIPMENT. DESIGN RIGHT ALL DESIGN RIGHTS RECORDED IN THIS DESIGN DOCUMENT ARE THE PROPERTY OF INNOVATE IT CAR WASH EQUIPMENT. THE DESIGN MUST NOT BE REPRODUCED WITHOUT EXPRESS WRITTEN PERMISSION OF INNOVATE IT CAR WASH EQUIPMENT. CONFIDENTIALITY THIS DRAWING MUST NOT BE DISCLOSED TO ANY THIRD PARTY WITHOUT THE EXPRESS WRITTEN PERMISSION OF INNOVATE IT CAR WASH EQUIPMENT.		DRAWN CJH	5/18/22	PROJECT: Wheel Blaster	
		CHKD		TITLE: PLC Node 1, Unit 1, Inputs 6-13	
		APPRVD		DRAWING NO: Wheel Blaster_480-120V_Wiring_ETH_Maple	
		ENG. INFO	XXXX	SIZE:	SCALE: NONE
		DO NOT SCALE DWG.		SHEET: PAGE 5 OF 10	REV: 02

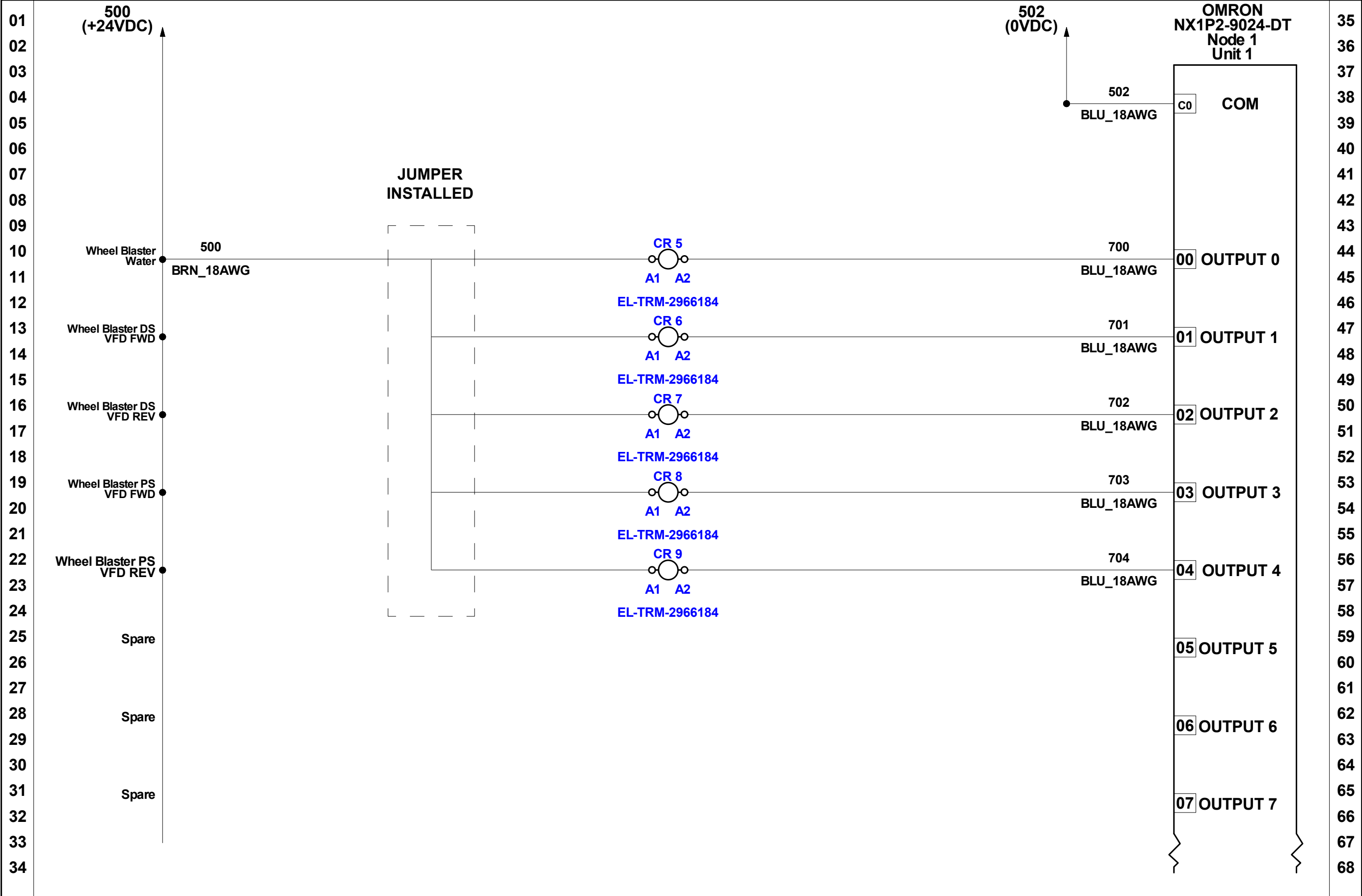

03			
02			
01	CJH	Drawing released	5/18/22
REV	BY	DESCRIPTION	DATE

THIS DRAWING IS THE PROPERTY OF INNOVATEIT		APPROVALS	DATE	INNOVATE IT CAR WASH EQUIPMENT
THIS DRAWING MUST NOT BE COPIED WITHOUT EXPRESS WRITTEN PERMISSION OF INNOVATE IT CAR WASH EQUIPMENT. DESIGN RIGHT		DRAWN CJH	5/18/22	
ALL DESIGN RIGHTS RECORDED IN THIS DESIGN DOCUMENT ARE THE PROPERTY OF INNOVATE IT CAR WASH EQUIPMENT. THE DESIGN MUST NOT BE REPRODUCED WITHOUT EXPRESS WRITTEN PERMISSION OF INNOVATE IT CAR WASH EQUIPMENT.		CHKD		PROJECT: Wheel Blaster
CONFIDENTIALITY		APPRVD		TITLE: PLC Node 1, Unit 1, Outputs 0-7
THIS DRAWING MUST NOT BE DISCLOSED TO ANY THIRD PARTY WITHOUT THE EXPRESS WRITTEN PERMISSION OF INNOVATE IT CAR WASH EQUIPMENT.		ENG. INFO	XXXX	DRAWING NO: Wheel Blaster_480-120V_Wiring_ETH_Maple
		DO NOT SCALE DWG.		SIZE: SCALE: NONE SHEET: PAGE 6 OF 10 REV: 02

01
02
03
04
05
06
07
08
09
10
11
12
13
14
15
16
17
18
19
20
21
22
23
24
25
26
27
28
29
30
31
32
33
34

102
(24VDCOM)
From 0345

Spare

Spare

Spare

Spare

Spare

Spare

Spare

Spare

OMRON
NX1P2-9024-DT
Node 1
Unit 1

08 OUTPUT 8

09 OUTPUT 9

10 OUTPUT 10

11 OUTPUT 11

12 OUTPUT 12

13 OUTPUT 13

14 OUTPUT 14

15 OUTPUT 15

35
36
37
38
39
40
41
42
43
44
45
46
47
48
49
50
51
52
53
54
55
56
57
58
59
60
61
62
63
64
65
66
67
68

THIS PAGE INTENTIONALLY LEFT BLANK

--	--	--	--

03			
02			
01	CJH	Drawing released	5/18/22
REV	BY	DESCRIPTION	DATE

THIS DRAWING IS THE PROPERTY OF		APPROVALS	DATE	INNOVATE IT CAR WASH EQUIPMENT	
 <small>THIS DRAWING MUST NOT BE COPIED WITHOUT EXPRESS WRITTEN PERMISSION OF INNOVATE IT CAR WASH EQUIPMENT. DESIGN RIGHT</small> <small>ALL DESIGN RIGHTS RECORDED IN THIS DESIGN DOCUMENT ARE THE PROPERTY OF INNOVATE IT CAR WASH EQUIPMENT. THE DESIGN MUST NOT BE REPRODUCED WITHOUT EXPRESS WRITTEN PERMISSION OF INNOVATE IT CAR WASH EQUIPMENT.</small> <small>CONFIDENTIALITY</small> <small>THIS DRAWING MUST NOT BE DISCLOSED TO ANY THIRD PARTY WITHOUT THE EXPRESS WRITTEN PERMISSION OF INNOVATE IT CAR WASH EQUIPMENT.</small>		DRAWN CJH	5/18/22	PROJECT: Wheel Blaster	
		CHKD		TITLE: PLC Node 1, Unit 1, Outputs 8-15	
		APPRVD		DRAWING NO: Wheel Blaster_480-120V_Wiring_ETH_Maple	
		ENG. INFO	XXXX	SIZE:	SCALE: NONE
		DO NOT SCALE DWG.		SHEET: PAGE 7 OF 10	REV: 02

TUNNEL CONTROLLER CONNECTIONS

01
02
03
04
05
06
07
08
09
10
11
12
13
14
15
16
17
18
19
20
21
22
23
24
25
26
27
28
29
30
31
32
33
34

35
36
37
38
39
40
41
42
43
44
45
46
47
48
49
50
51
52
53
54
55
56
57
58
59
60
61
62
63
64
65
66
67
68

Tire Tunnel Function
120 VAC

Conveyor Running
120 VAC

Collision Monitor
120 VAC

Pulse Switch
24 VAC/DC

wheelblastIT Water Solenoid Output
DRY CONTACT

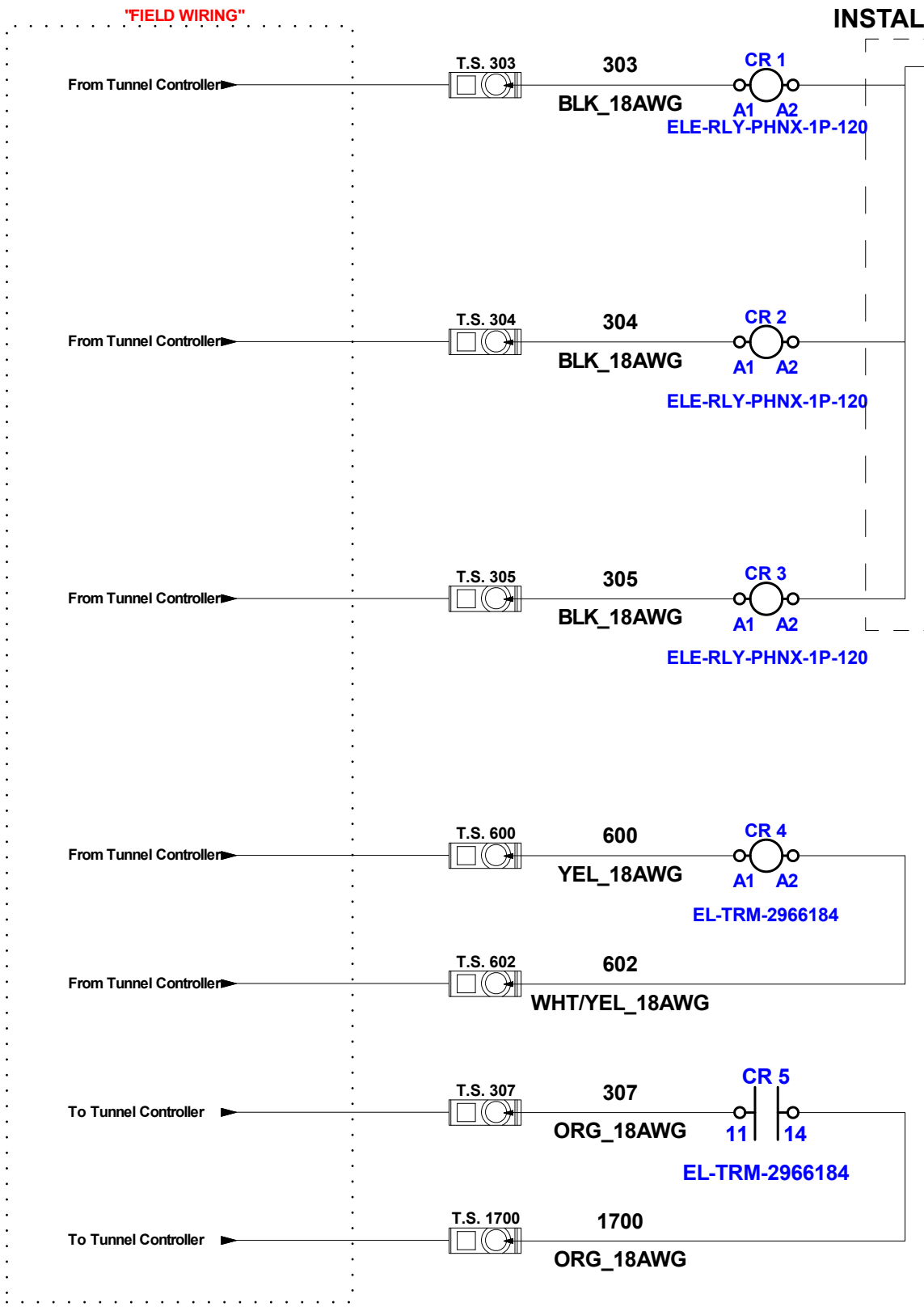

Note:
Run individual conductors, do not jumper terminals.

03			
02			
01	CJH	Drawing released	5/18/22
REV	BY	DESCRIPTION	DATE

THIS DRAWING IS THE PROPERTY OF INNOVATE IT		APPROVALS	DATE	INNOVATE IT CAR WASH EQUIPMENT	
THIS DRAWING MUST NOT BE COPIED WITHOUT EXPRESS WRITTEN PERMISSION OF INNOVATE IT CAR WASH EQUIPMENT. DESIGN RIGHT ALL DESIGN RIGHTS RECORDED IN THIS DESIGN DOCUMENT ARE THE PROPERTY OF INNOVATE IT CAR WASH EQUIPMENT. THE DESIGN MUST NOT BE REPRODUCED WITHOUT EXPRESS WRITTEN PERMISSION OF INNOVATE IT CAR WASH EQUIPMENT. CONFIDENTIALITY THIS DRAWING MUST NOT BE DISCLOSED TO ANY THIRD PARTY WITHOUT THE EXPRESS WRITTEN PERMISSION OF INNOVATE IT CAR WASH EQUIPMENT.		DRAWN CJH	5/18/22	PROJECT: Wheel Blaster	
		CHKD		TITLE: Tunnel Controller Connections	
		APPRVD		DRAWING NO: Wheel Blaster_480-120V_Wiring_ETH_Maple	
		ENG. INFO	XXXX	SIZE:	SCALE: NONE
		DO NOT SCALE DWG.		SHEET: PAGE 8 OF 10	REV: 02

01
02
03
04
05
06
07
08
09
10
11
12
13
14
15
16
17
18
19
20
21
22
23
24
25
26
27
28
29
30
31
32
33
34

35
36
37
38
39
40
41
42
43
44
45
46
47
48
49
50
51
52
53
54
55
56
57
58
59
60
61
62
63
64
65
66
67
68

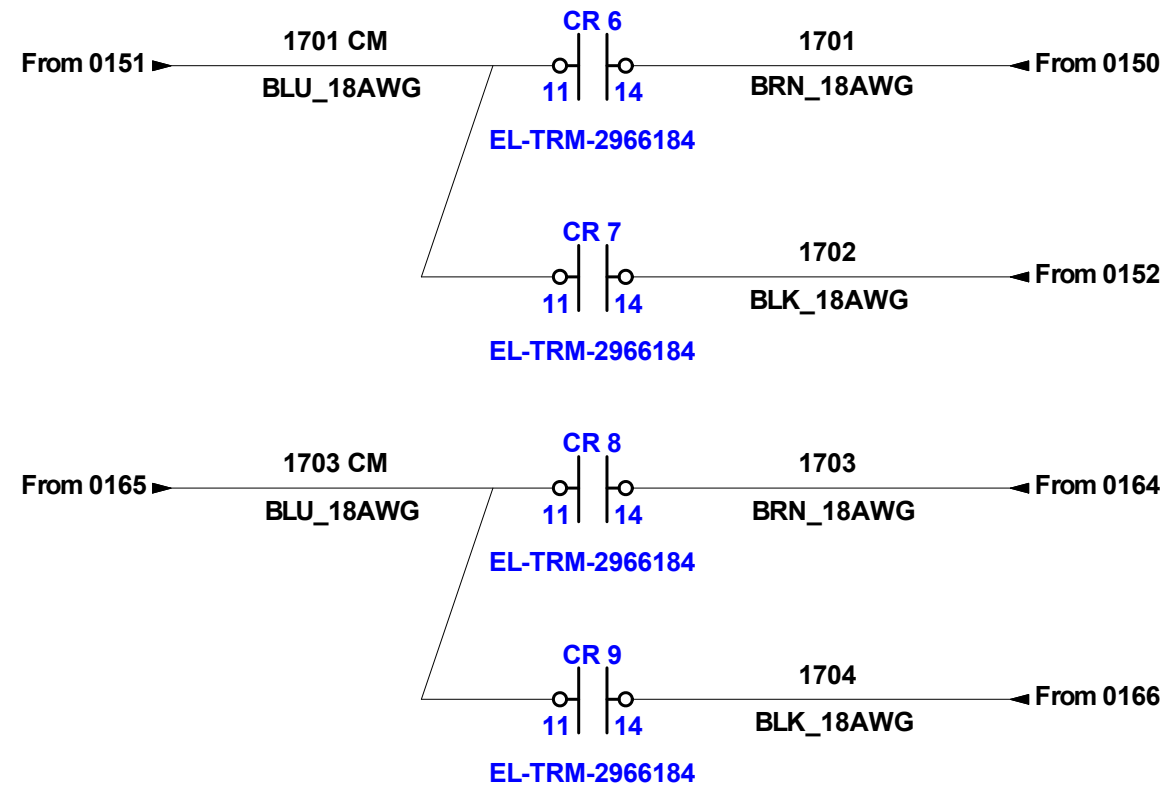

Note:
Jumper CR 6+7 Pin 11
Jumper CR 8+9 Pin 11

03			
02			
01	CJH	Drawing released	5/18/22
REV	BY	DESCRIPTION	DATE

THIS DRAWING IS THE PROPERTY OF INNOVATE IT		APPROVALS	DATE	INNOVATE IT CAR WASH EQUIPMENT	
THIS DRAWING MUST NOT BE COPIED WITHOUT EXPRESS WRITTEN PERMISSION OF INNOVATE IT CAR WASH EQUIPMENT. DESIGN RIGHT ALL DESIGN RIGHTS RECORDED IN THIS DESIGN DOCUMENT ARE THE PROPERTY OF INNOVATE IT CAR WASH EQUIPMENT. THE DESIGN MUST NOT BE REPRODUCED WITHOUT EXPRESS WRITTEN PERMISSION OF INNOVATE IT CAR WASH EQUIPMENT. CONFIDENTIALITY THIS DRAWING MUST NOT BE DISCLOSED TO ANY THIRD PARTY WITHOUT THE EXPRESS WRITTEN PERMISSION OF INNOVATE IT CAR WASH EQUIPMENT.		DRAWN CJH	5/18/22	PROJECT: Wheel Blaster	
		CHKD		TITLE: VFD Forward / Reverse Signals	
		APPRVD		DRAWING NO: Wheel Blaster_480-120V_Wiring_ETH_Maple	
		ENG. INFO	XXXX	SIZE:	SCALE: NONE
		DO NOT SCALE DWG.		SHEET: PAGE 9 OF 10	REV: 02

01
02
03
04
05
06
07
08
09
10
11
12
13
14
15
16
17
18
19
20
21
22
23
24
25
26
27
28
29
30
31
32
33
34

35
36
37
38
39
40
41
42
43
44
45
46
47
48
49
50
51
52
53
54
55
56
57
58
59
60
61
62
63
64
65
66
67
68

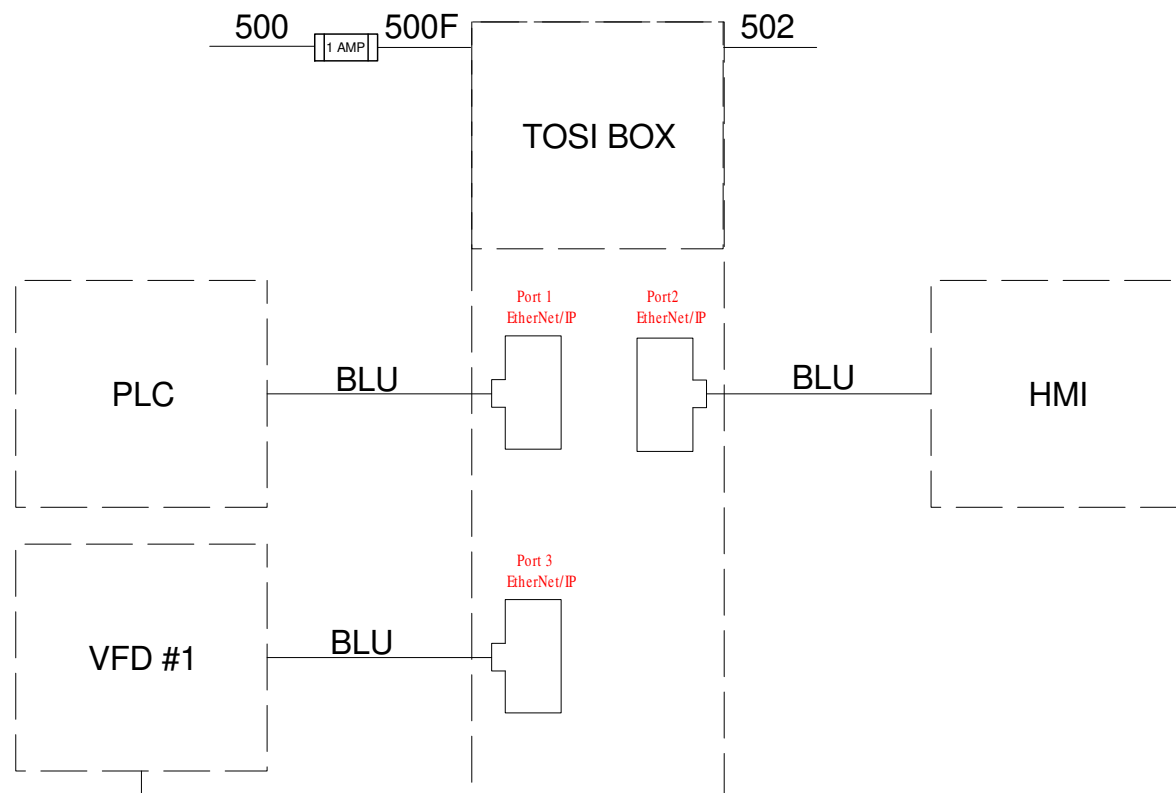

ETHERNET CONNECTIONS
PORT 1 TO PLC "ETHERNET IP" PORT
PORT 2 TO HMI SCREEN
PORT 3 TO VFD #1

--	--	--	--

03			
02			
01	CJH	Drawing released	5/18/22
REV	BY	DESCRIPTION	DATE

THIS DRAWING IS THE PROPERTY OF		APPROVALS	DATE	INNOVATE IT CAR WASH EQUIPMENT	
 <small>THIS DRAWING MUST NOT BE COPIED WITHOUT EXPRESS WRITTEN PERMISSION OF INNOVATE IT CAR WASH EQUIPMENT. DESIGN RIGHT ALL DESIGN RIGHTS RECORDED IN THIS DESIGN DOCUMENT ARE THE PROPERTY OF INNOVATE IT CAR WASH EQUIPMENT. THE DESIGN MUST NOT BE REPRODUCED WITHOUT EXPRESS WRITTEN PERMISSION OF INNOVATE IT CAR WASH EQUIPMENT. CONFIDENTIALITY THIS DRAWING MUST NOT BE DISCLOSED TO ANY THIRD PARTY WITHOUT THE EXPRESS WRITTEN PERMISSION OF INNOVATE IT CAR WASH EQUIPMENT.</small>		DRAWN CJH	5/18/22	PROJECT: Wheel Blaster	
		CHKD		TITLE: Ethernet Connections	
		APPRVD		DRAWING NO: Wheel Blaster_480-120V_Wiring_ETH_Map	
		ENG. INFO	XXXX	SIZE: DO NOT SCALE DWG.	SCALE: NONE

